

## 830nm Infrared Diode Laser



### †Specifications

Product Code	SSL - 830 - XXXX - XXM - D
Wavelength [ nm ]	830 ±3
Output Power [ mW ]	1 - 2000
Transverse Mode	TE <sub>00</sub> / CW
Operating Temperature [ °C ]	+10 - +35
Storage Temperatures [ °C ]	-10 - +45
Warm-up Time [ minutes ]	< 5
Power Stability [ rms, over 4 hours ]	5%, 3%, 1%
M <sup>2</sup> Factor	< 15
Beam Diameter At The Aperture [ mm ]	~ 4.0 × 6.0
Beam Divergence, Full Angle [ mrad ]	< 2.0
Spectral Linewidth [ nm ]	< 1.0
Polarization Ratio	> 50 : 1
Point Stability After Warm-up [ mrad ]	< 0.05
Noise of Amplitude [ rms ]	< 30%
Modulation [ TTL or Analog Alternative ]	Standard 10KHz, Up to 40KHz need request
Laser Head Dimensions [ mm ]	135 [L] × 75 [W] × 45 [H]
Power Supply Dimensions [ mm ]	130 [L] × 120 [W] × 55 [H]
Working Voltage [ VAC ]	85~245, 50/60Hz
Laser Gross Weight [ kg ]	1.5
Cooling Way	Cooled by TEC and air
Expected Lifetime [ hours ]	> 10000
Warranty Time [ year ]	1

#### Laser Head Dimension:

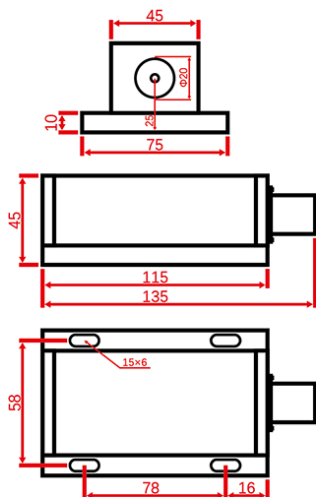

#### Power Supply Dimension:

