

1064nm Infrared DPSS Low Noise Laser



†**Specifications**

Product Code	SSL - 1064 - XXXX - LN - LED
Wavelength [nm]	1064
Output Power [mW] [0 - Max Adjustable]	2500 - 4000
Transverse Mode	TEM ₀₀ / CW
Operating Temperature [°C]	+10 - +35
Storage Temperatures [°C]	-10 - +45
Warm-up Time [minutes]	< 15
Power Stability [rms, over 4 hours]	5%, 3%, 1%
M² Factor	< 1.5
Beam Diameter At The Aperture [mm]	~ 2.0
Beam Divergence, Full Angle [mrad]	< 2.0
Spectral Linewidth [nm]	< 0.1
Polarization Ratio	> 100 : 1
Point Stability After Warm-up [mrad]	< 0.05
Noise of Amplitude [rms]	< 1%
Laser Head Dimensions [mm]	160 [L] × 78 [W] × 60 [H]
Power Supply Dimensions [mm]	260 [L] × 145 [W] × 105 [H]
Working Voltage [VAC]	85~245, 50/60Hz
Laser Gross Weight [kg]	3.5
Cooling Way	Cooled by TEC and air
Expected Lifetime [hours]	> 10000
Warranty Time [year]	1

Laser Head Dimension:

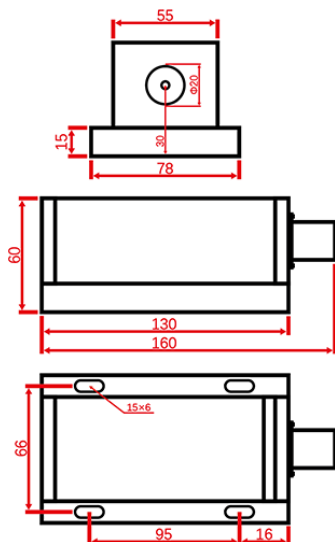

Power Supply Dimension:

