

**980nm Infrared Diode Low Noise Laser**



†**Specifications**

<b>Product Code</b>	SSL - 980 - XXXX - LN - LED
<b>Wavelength [ nm ]</b>	980 ±5
<b>Output Power [ mW ] [ 0 - Max Adjustable ]</b>	1 - 2500
<b>Transverse Mode</b>	TE <sub>00</sub> / CW
<b>Operating Temperature [ °C ]</b>	+10 - +35
<b>Storage Temperatures [ °C ]</b>	-10 - +45
<b>Warm-up Time [ minutes ]</b>	< 5
<b>Power Stability [ rms, over 4 hours ]</b>	5%, 3%, 1%
<b>M<sup>2</sup> Factor</b>	< 15
<b>Beam Diameter At The Aperture [ mm ]</b>	~ 4.0 × 5.0
<b>Beam Divergence, Full Angle [ mrad ]</b>	< 2.0
<b>Spectral Linewidth [ nm ]</b>	< 1.0
<b>Polarization Ratio</b>	> 50 : 1
<b>Point Stability After Warm-up [ mrad ]</b>	< 0.05
<b>Noise of Amplitude [ rms ]</b>	< 1%
<b>Laser Head Dimensions [ mm ]</b>	135 [L] × 75 [W] × 45 [H]
<b>Power Supply Dimensions [ mm ]</b>	140 [L] × 140 [W] × 85 [H]
<b>Working Voltage [ VAC ]</b>	85~245, 50/60Hz
<b>Laser Gross Weight [ kg ]</b>	2.0
<b>Cooling Way</b>	Cooled by TEC and air
<b>Expected Lifetime [ hours ]</b>	> 10000
<b>Warranty Time [ year ]</b>	1

**Laser Head Dimension:**

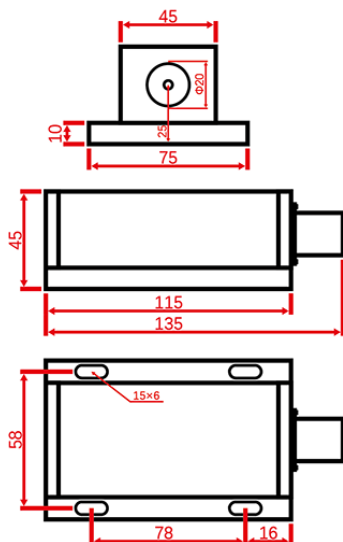

**Power Supply Dimension:**

